

# ROCOM

- D** EX PBX Kurzbedienungsanleitung
- GB** EX PBX quick guide
- I** EX PBX guida rapida

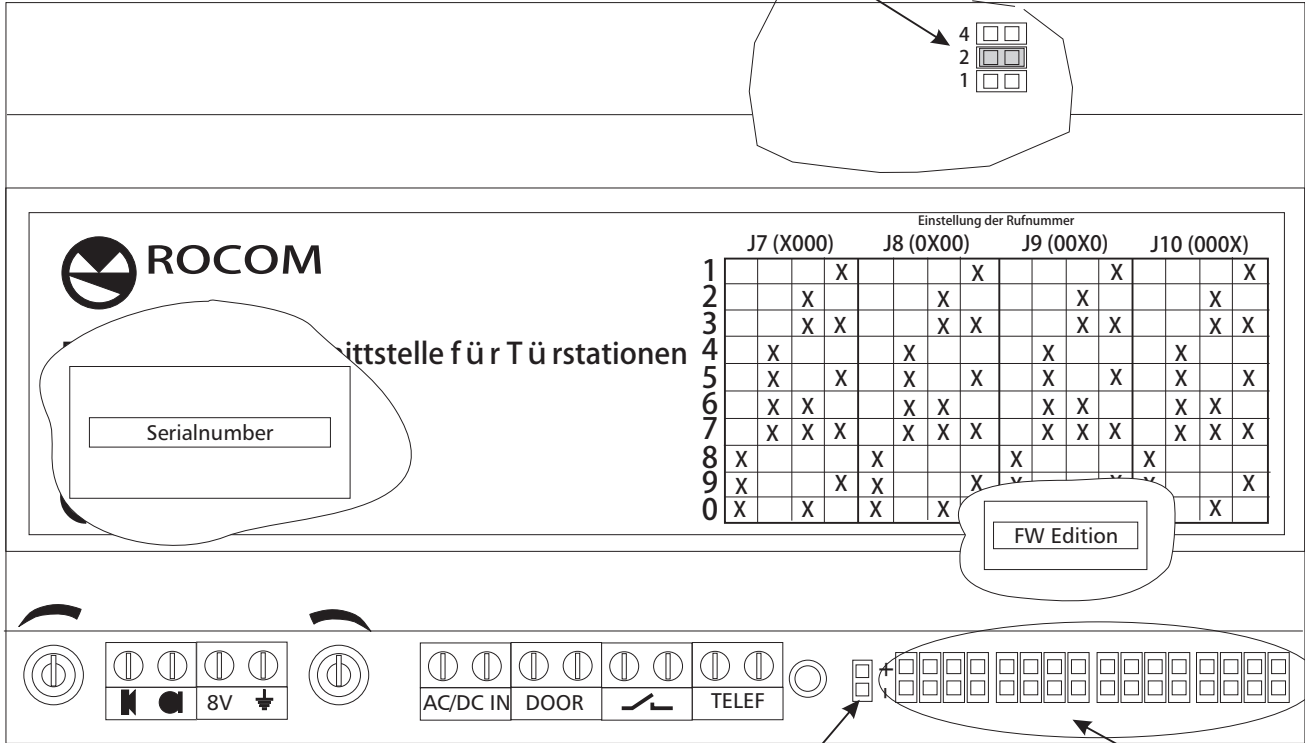

Optional  
+ -  
Siehe nächste Seite  
See next page  
Vedi pagina seguente

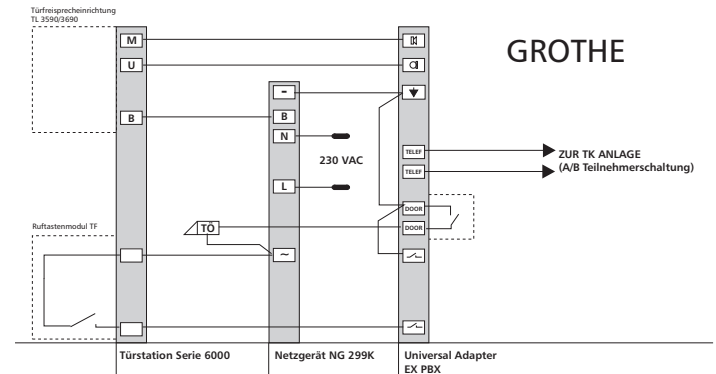
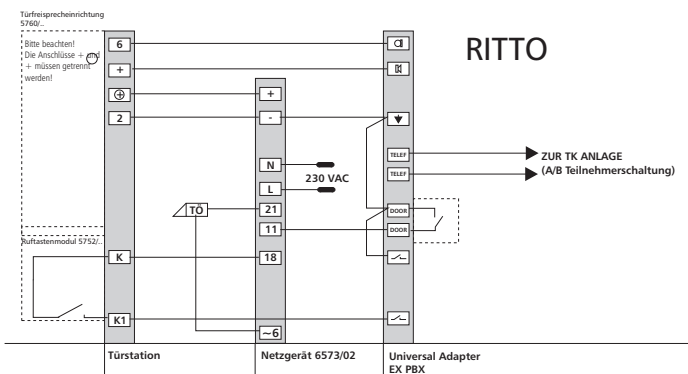
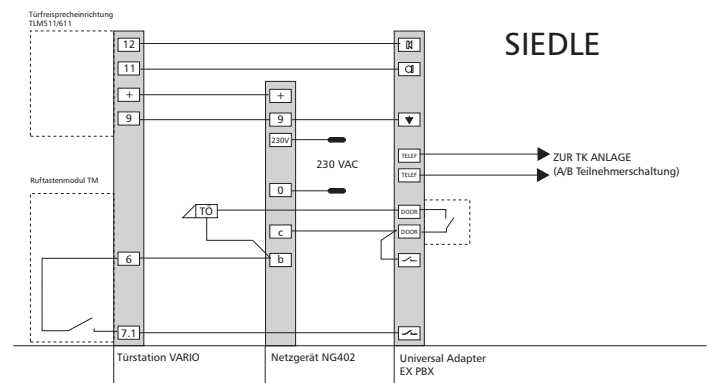
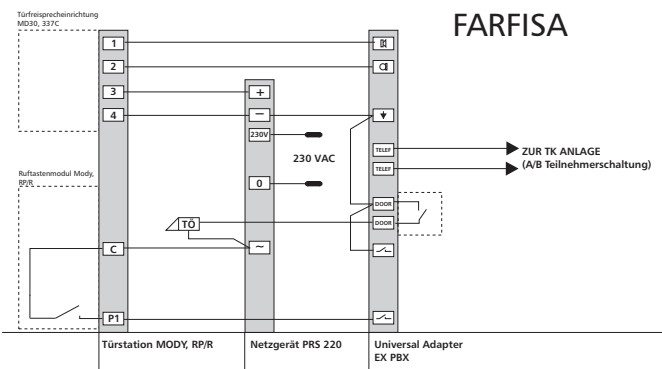

- D** EX PBX Programmierung
- GB** EX PBX programming
- I** EX PBX programmazione

Programmierung der Rufnummern/telephon no. programming/programmazione nr. di telefono

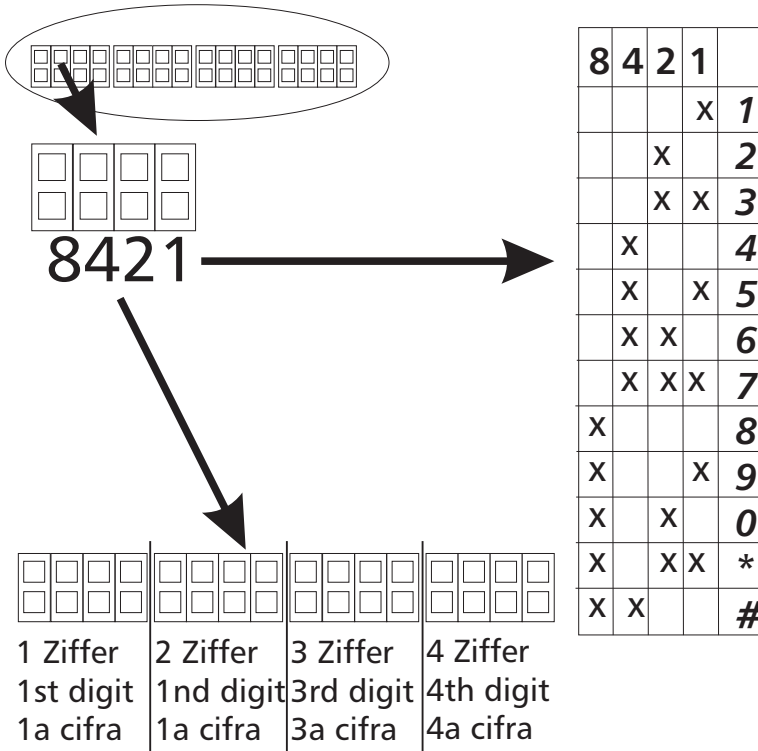

Beispiele/example/esempi

Se möchten die Rufnummer anrufen/you want to dial the telephone #/volete chiamare il nr. telefonico:

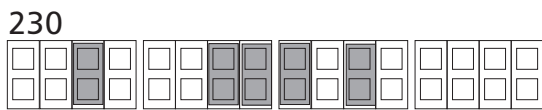
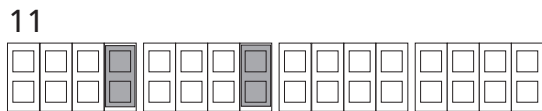

Bedienungsanleitung/user guide/guida all'uso

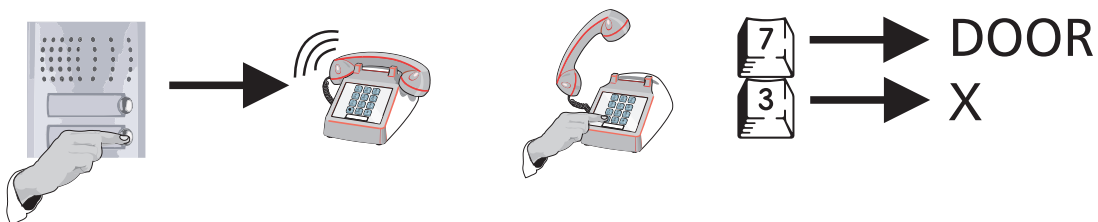

Quickmarks. Download reader for mobile phone: <http://www.quickmark.com.tw/En/basic/download.asp>



Bedienungsanleitung  
EX PBX  
komplett, deutsch



User guide  
EX PBX  
complete, english